

OUTLINE DIMENSIONAL DRAWING

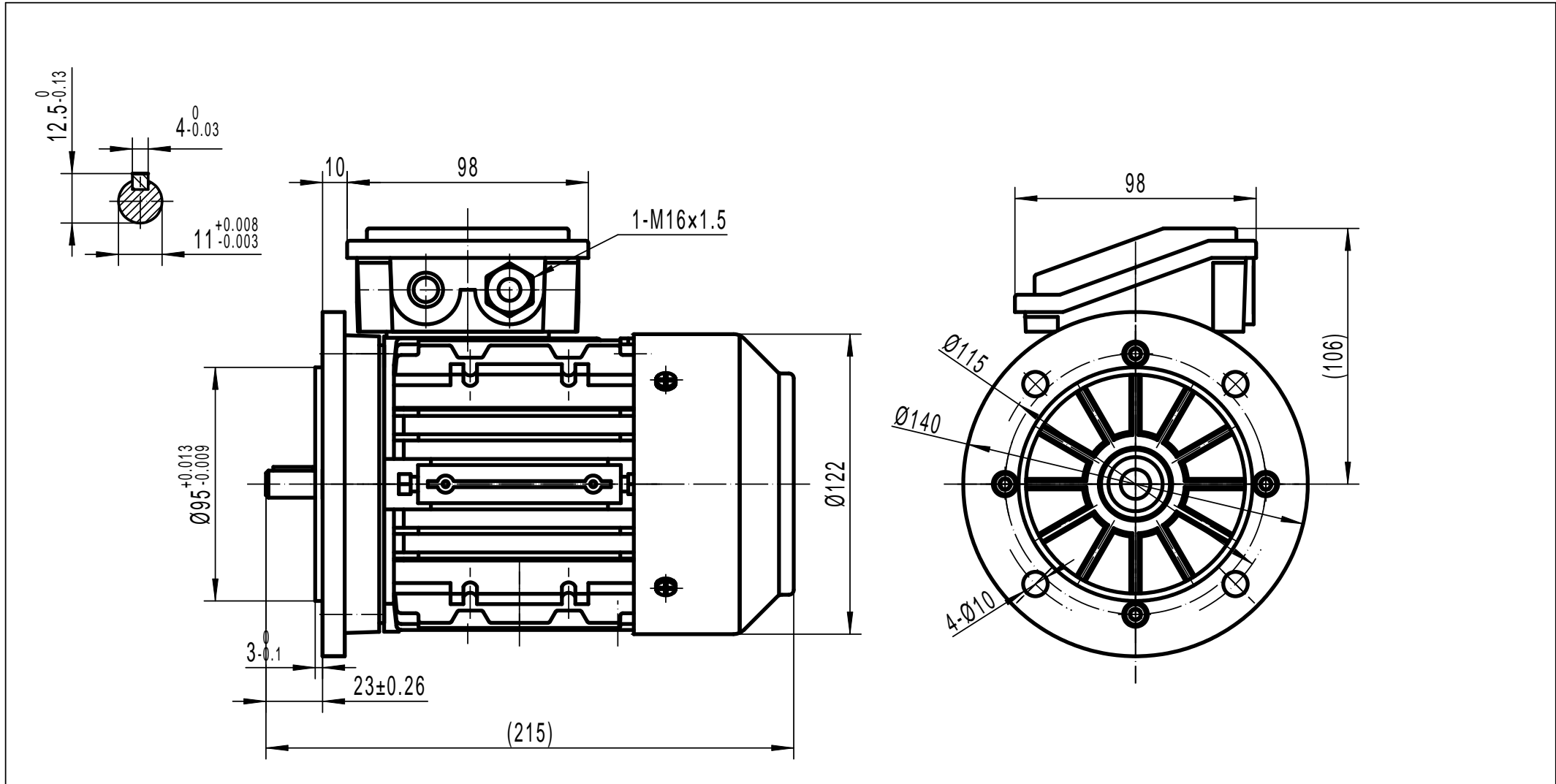

TECHTOP AUSTRALIA PTY LTD	
FRAME	TAI 63A B5
DATE	DRAWING NO.
2011/10/14	1ST081.055.001-010 A